

- When using the products covered herein, please observe the conditions written herein and the precautions outlined in the following paragraphs. In no event shall the company be liable for any damages resulting from failure to strictly adhere to these conditions and precautions.

① The products covered herein are designed and manufactured for the following application areas. When using the products covered herein for the equipment listed in paragraph (2), even for the following application areas, be sure to observe the precautions given in Paragraph (2). Never use the products for the equipment listed in Paragraph (3).

- Office electronics
- Instrumentation and measuring equipment
- Machine tools
- Audiovisual equipment
- Home appliances
- Communication equipment other than for trunk lines

② These contemplating using the products covered herein for the following equipment which demands high reliability, should first contact a sales representative of the company and then accept responsibility for incorporating into the design fail-safe operation, redundancy, and other appropriate measures for ensuring reliability and safety of the equipment and the overall system.

- Control and safety devices for airplanes, trains, automobiles, and other transportation equipment
- Mainframe computers
- traffic control systems
- Gas leak detectors and automatic cutoff devices
- Rescue and security equipment
- Other safety devices and safety equipment, etc.

③ Do not use the products covered herein for the following equipment which demands extremely high performance in terms of functionality, reliability, or accuracy

- Aerospace equipment
- Communications equipment for trunk lines
- Control equipment for the nuclear power industry
- Medical equipment related to life support, etc.

④ Please direct all queries and comments regarding the interpretation of the above three Paragraphs to a sales representative of the company.

- Please direct all queries regarding the products covered herein to a sales representative of the company.

- Handle this document carefully for it contains material protected by international copyright law.

Any reproduction, full or in part, of this material is prohibited without the express written permission of the company.

This application does not assure or permit the execution of the industrial property and other rights. Moreover, when the problem of related to the industrial property with the third party occurs by having used the product of our company for other usages, in no event shall the company be liable for any damages.

CONTENTS

1	Overview	3
2	Feature.....	3
3	Terminal arrangement(back side of the module).....	4
4	Equivalent circuit.....	5
5	Specifications	6
5.1	Materials	6
5.1.1	Solar cells.....	6
5.1.2	Transparent resin	6
5.1.3	Board of the solar cell module	6
5.1.4	Die bonding material	6
5.1.5	Wire bonding material	6
5.2	Design and Structure.....	6
5.2.1	General.....	6
5.2.2	Interconnection of solar cells.....	6
5.2.3	Output terminal	6
5.2.4	Mass	6
5.2.5	Outline dimension of the solar cell module	7
5.2.6	The exposed plating part of the side of the module's long side.....	7
6	Absolute Maximum Ratings.....	8
7	Electric characteristics.....	8
7.1	Output characteristics	8
7.2	Irradiant characteristics (example of representative characteristic).....	9
7.3	Temperature characteristics (example of representative characteristic).....	9
7.4	Temperature rise characteristic at short-circuit	10

8	Shipping Test	11
8.1	Test category.....	11
8.2	Criteria of module size.....	11
8.3	Characteristic test conditions	11
8.4	Visual Inspection Standards.....	12
9	Precautions for safe usage	13
9.1	Handling	13
9.2	Mounting	13
9.3	Using	13
10	Others	13
11	Package and packing specification	14

1 Overview

This specification is applicable to LROGC02 solar cell module. This product is the half-finished product that is required to be made to the final product.

2 Feature

- This module can charge the storage battery with portable equipment.
- Output power is typ 300mW(when 25°C AM1.5 1000W/m²).
- 10 solar cells are connected with the series, so the electric power loss can be reduced when using a boost converter.

3 Terminal arrangement (back side of the module)

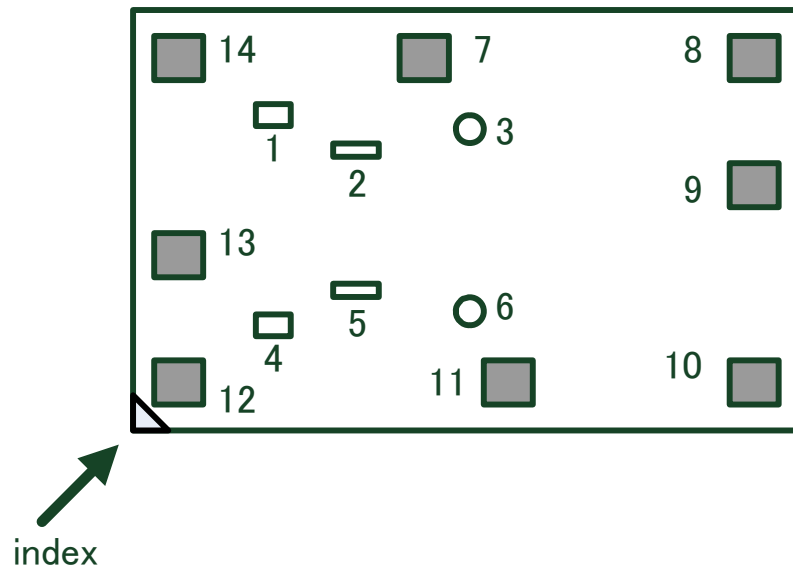

Fig.1 Terminal arrangement of the back side of the module

Note) This picture is not the outline dimension, but the image.

Table.1 Terminal description

Pin No	Pin name	Description	Note
1	OUTPUTA	+ terminal	
2	OUTPUTB	+ terminal	
3	Test terminal	+ terminal	
4	OUTPUTC	- terminal	
5	OUTPUTD	- terminal	
6	Test terminal	- terminal	
7 ~ 14	GND terminal	EMI noise measures	1)

Note 1)

The peripheral quadrangle terminals 7~14 are the GND part of the module, they are not connected with 1~6 terminals. The GND metal pattern is wired in the module for the general EMI noise measures, and all of the peripheral quadrangle terminals 7~14 should be connected with GND (but this GND is different from - terminals 4~6) for the noise measures. However, it does not mean that this module itself radiates noise, and there is no influence on the electrical characteristics even when these terminals are not connected with GND.

4 Equivalent circuit

The equivalent circuit of the solar cell module is shown below.

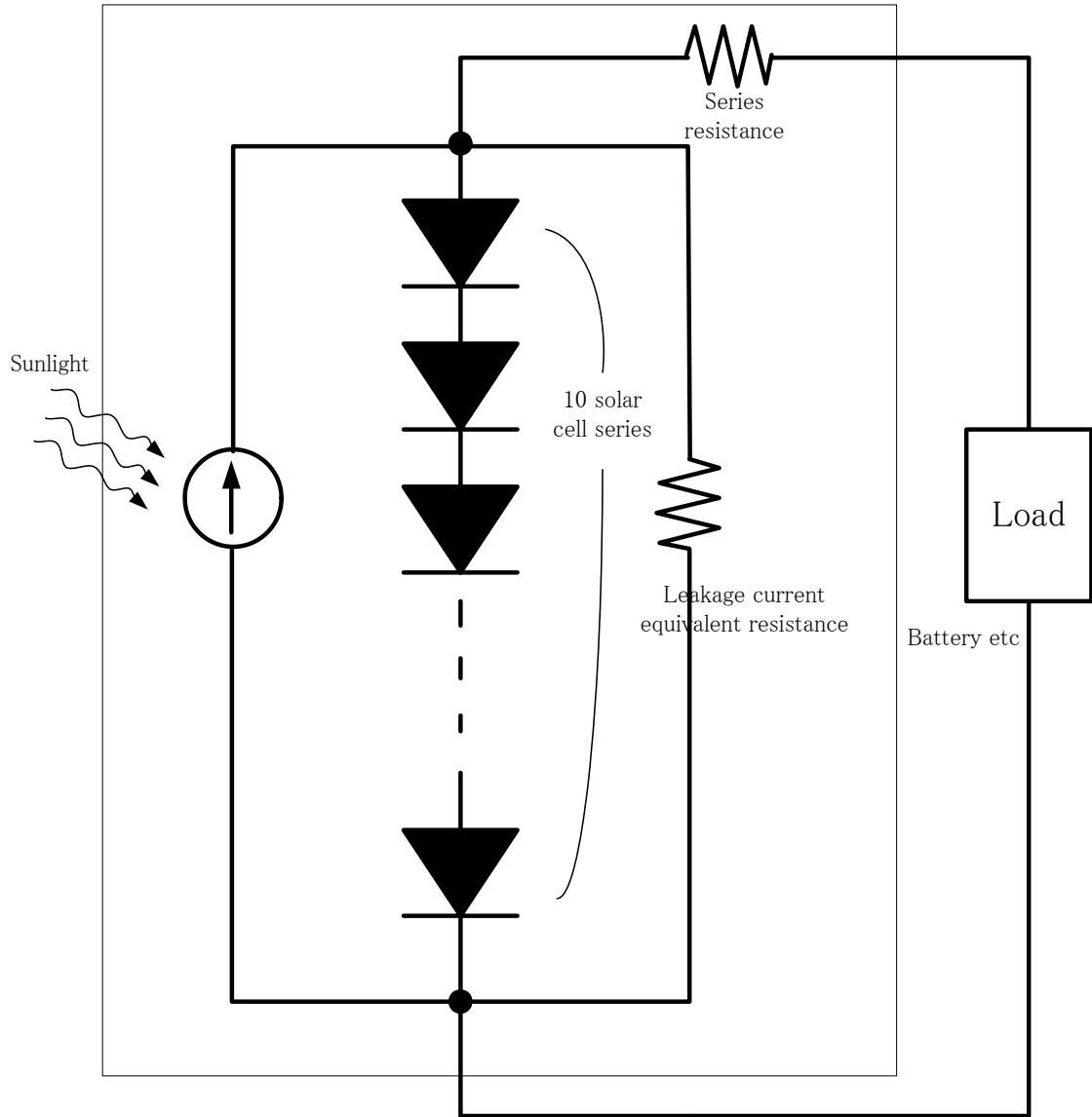

Fig.2 The equivalent circuit of the solar cell module

5 Specifications

5.1 Materials

This specification provides materials of the solar cell module. However, in case of no provision, materials that match the performance of the solar cell module shall be used.

5.1.1 Solar cells

Solar cells shall be produced from poly-crystalline silicon.

5.1.2 Transparent resin

Transparent resin shall be epoxy resin.

5.1.3 Board of the solar cell module

Board of the solar cell module shall be produced mainly from glass epoxy resin.

5.1.4 Die bonding material

Die bonding material between the solar cell and the board shall be Ag paste.

5.1.5 Wire bonding material

Wire bonding material between the solar cell and the board shall be Au wire.

5.2 Design and Structure

5.2.1 General

The solar cell module shall be sealed in a transparent resin. The solar cell module becomes a final product with the covers.

5.2.2 Interconnection of solar cells

The board of the solar cell module (chap 5.1.3), the die bonding material (chap 5.1.4), and the wire bonding material (chap 5.1.5) are used for the connection between the solar cells. The surface of the board of the solar cell module has area for 10 solar cells' die bonding, and the terminals for wire bonding. First, the die bonding between the 10 solar cells and the board of the solar cell module is done with the die bonding material. Next, the wire bonding between the terminals of the solar cell and the terminals of the board of the solar cell module is done with the wire bonding material. Last, all of the 10 solar cells are interconnected in series.

5.2.3 Output terminal

The output terminal is located on the back side of the board of the solar cell.

5.2.4 Mass

The typical mass of solar cell module is about 4.3g / piece.

5.2.5 Outline dimension of the solar cell module

The outline dimension of the solar cell module (typ.) is 41.0mm (W) X 67.5mm (H) X 0.8mm (D).
 The amount of warp is max. 0.8mm when shipping the solar cell module (under the environment temp 25°C humidity 60%). Please note that the amount of warp changes depending on the temperature and humidity. About the temperature characteristic, the amount of warp changes max. 0.55mm into the direction of the valley spring when changing temp from 25 to 85 degrees. About the humidity characteristic, the amount of warp changes max. 0.5mm into the direction of the mountain spring, when putting it into the state of the saturation moisture uptake of temp 40°C humidity 90%.

Note) The condition of warp is shown below. When assuming the surface of the module turns to the upper part, the left side of the figure below is called a valley spring, and the right side of the figure below is called a mountain spring. The amount of warp is measured by the difference of the upper and the lower bound of the module height, that scanned by the module diagonal.

※To suppress the influence on the warp, all aspects of the module are recommended to be fixed.

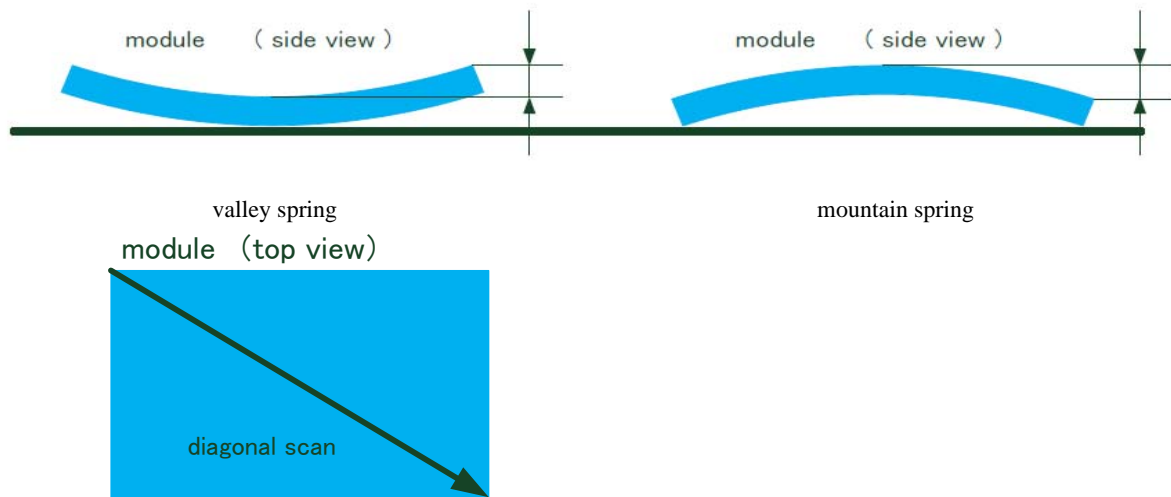
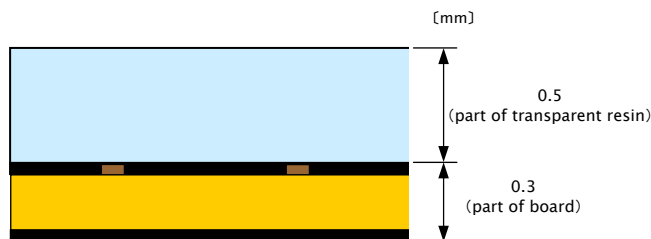

Fig.3 Definition of the module's warp

5.2.6 The exposed plating part of the side of the module's long side

The plating part that leads to wiring in the module has been exposed to the side of the module's long side. Please do not allow the material with electroconductive to touch in the plating part. Please refer to the figure below for the outcrop size.

The exposed plating part (Length about 0.03×Width about 0.06)



The side of the module's long side

Fig.4 Module's long side

6 Absolute Maximum Ratings

Table.2 Absolute maximum ratings

Category	Symbol	Unit	Value
Storage Temp	Tstg	°C	-30~+85
Operating Temp	Tj	°C	-20~+70
Resist Voltage	Vr	V	-1.4
Inflow Current	Iin	mA	1.00

Note) The absolute maximum ratings mean the limit value that can not exceed in an instant. The absolute maximum ratings do not mean the limit value of the environmental condition that maintain the performance when shipping the solar cell module. But, the absolute maximum ratings mean the limit value of the condition that becomes a fatal breakdown (the solar cell module does not operate, etc).

7 Electric characteristics

7.1 Output characteristics

The output characteristics of the module follow table.3 under standard test conditions. We do not ensure the typical value of the electric output characteristics of the module. These characteristics are the output characteristics of the half-finished product. However, the output characteristic in the table.1 is not warrantable when there are dirt of the transparent resin and deterioration even in case of the standard. Moreover, please refer to 7.2 irradiant characteristics and 7.3 temperature characteristics for the output characteristic in case of the standard condition.

Table.3 Output Characteristics

Characteristic	Symbol	Typical	Min	Max	Unit
Open Circuit Voltage	Voc	5.7	5.2	—	V
Short Circuit Current	Isc	75	62	—	mA
Maximum Power Voltage	Vpm	4.5	3.8	—	V
Maximum Power Current	Ipm	65	48	—	mA
Maximum Power	Pm	300	240	—	mW
Inverse Leak Current (in -4.2V)	Ir	0.15	—	4	mA

Standard Test Condition

- module temperature : 25 °C±3°C
- spectrum distribution : AM1.5 reference solar radiation
(conformed by JIS C 8911 standards)
- irradiance : 1000±50 W/m²

7.2 Irradiant characteristics (example of representative characteristic)

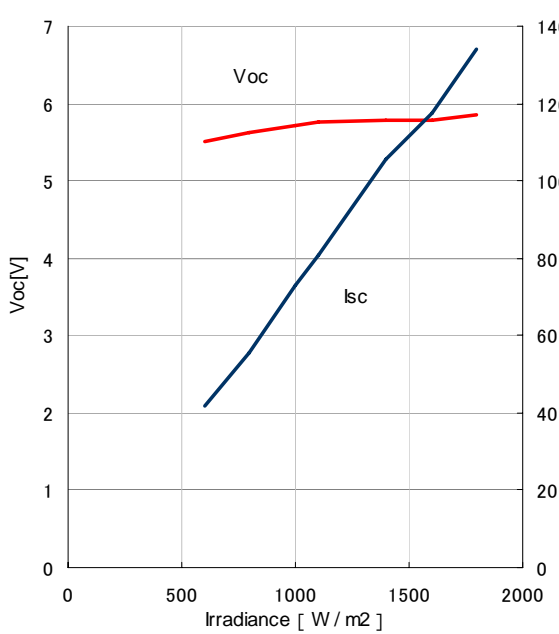

Open circuit voltage, Short circuit current vs. Irradiance Characteristics

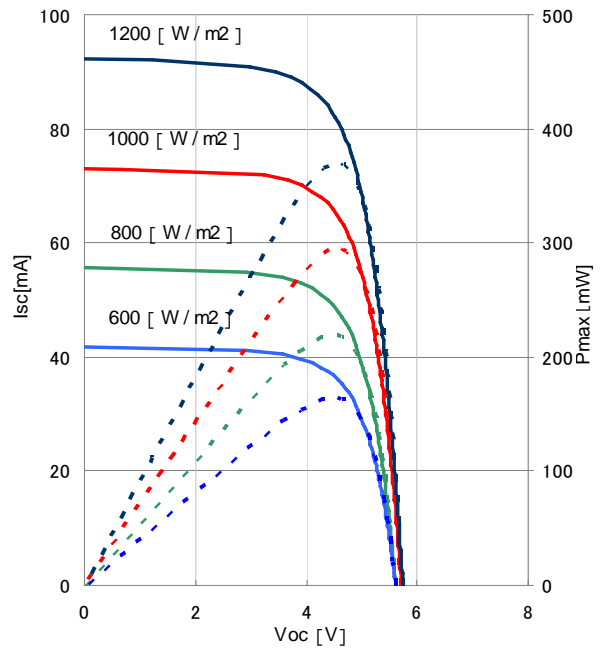

Current, Power - Voltage Characteristics

7.3 Temperature characteristics (example of representative characteristic)

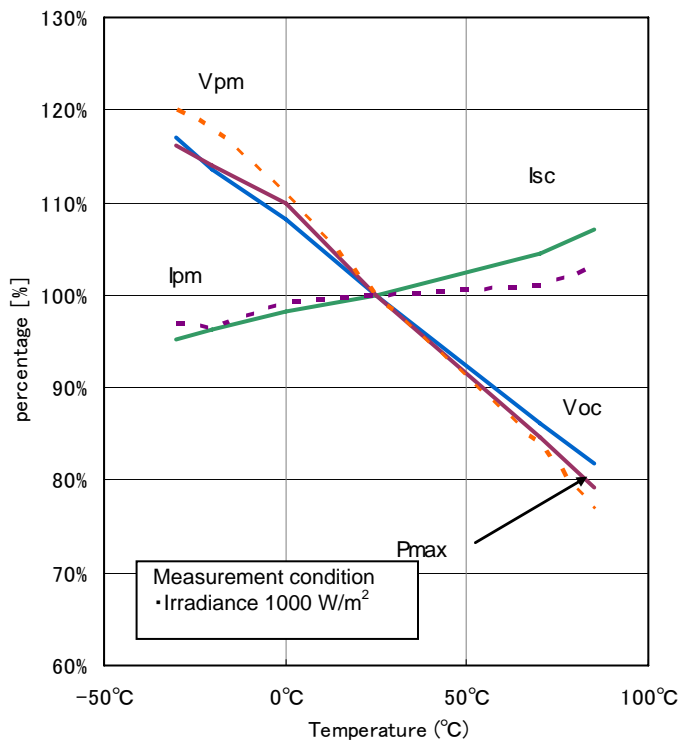

Normalized Isc · Voc · Pmax · Ipm · Vpm Temperature characteristics

7.4 Temperature rise characteristic at short-circuit (example of representative characteristic)

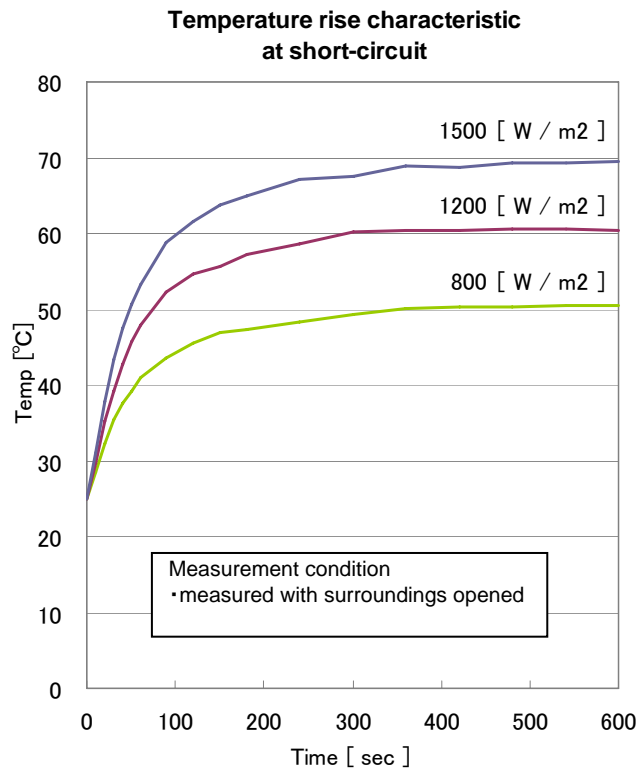

8 Shipping Test

Each shipping module shall successfully pass the shipping tests.

8.1 Test category

The category of the shipping test is the size (length, width), the characteristics, and the visual.

8.2 Criteria of module size

(1) length : (outline dimension) $\pm 0.1\text{mm}$

(2) width : (outline dimension) $\pm 0.1\text{mm}$

8.3 Characteristic test conditions

(1) source of light : solar simulator (Air Mass 1.5 filter use)

(2) irradiance : $1000\pm 50 \text{ W/m}^2$

(3) module temperature : $25\pm 3^\circ\text{C}$

8.4 Visual Inspection Standards

Table. 4 Visual Inspection Standards

No	Category	Criteria	Method
1	Crack	There shall be no crack of the module. However, the wound in the back side solder mask is assumed to be prepermission excluding the copper foil exposure. Moreover, the wound of the terminal is assumed not to see the groundwork (copper).	Visual inspection by naked eye
2	Loss of the front surface electrode	The criteria of the disconnection of the grid line is the one more than the stroke width of the subgrid (about 0.15mm width). (Refer to Fig.5) And, the parts of frame outside the cell in the package (about 2.2mm width, about 1.9mm width) is assumed prepermission. (Refer to Fig.6 for the part of frame) However, the electrical characteristics are satisfied.	Visual inspection by naked eye
3	Dust or Void	The dust or the void attached on the surface parts of frame outside the cell in the package (about 2.2mm width, about 1.9mm width) under 0.5mm length is assumed prepermission. (Refer to Fig.6 for the part of frame) Moreover, the dust under ϕ 1mm in the back parts of frame is assumed prepermission. And the dust which can be removed by wiping off on the surface and the back side is assumed prepermission.	Visual inspection by naked eye

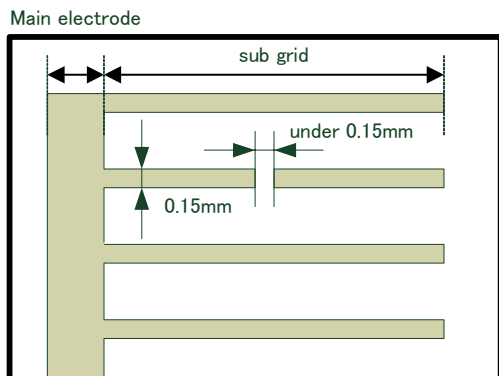

Fig. 5 : The criteria of the disconnection of the grid line in each solar cell

The criteria of the disconnection of the grid line is the one more than the stroke width of the subgrid.

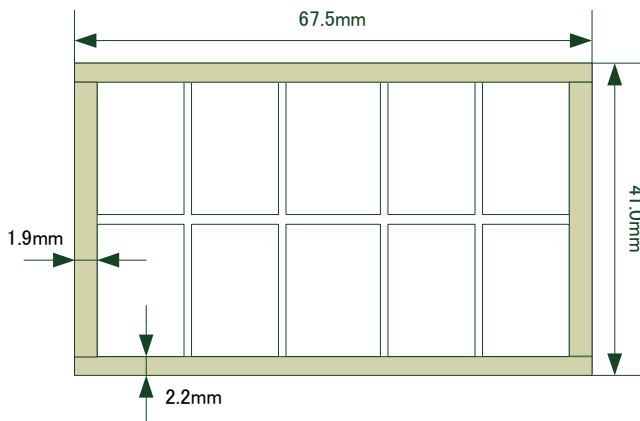

Fig. 6 : Frame outside cell on surface side

Module' s long side : about 2.2mm width
Module' s short side: about 1.9mm width

9 Precautions for safe usage

Here are basic precautions for safe usage.

9.1 Handling

- (1) When you mount or wire connect the module, please be careful not to apply load to particular part of the module. It will be the cause of transparent resin crack or solar cell crack.
- (2) Terminals of the solar cell mounted board are exposed at back side of the module, and the rest is covered with thin over coat. There may be scratch or damage if you contact a hard material. If the thin over coat at back side of the module is damaged, proofness will go down, and there may be failure in electric characteristics.
- (3) If you drop the module or drop hard material like industrial tool on the module, transparent resin may be damaged. Do not use the module if the transparent resin is damaged.
- (4) When you put down the module, please put down gently, not to apply shock to the module. Solar cell may crack and there may be electric characteristics failure.
- (5) When you handle the module please use thumbstall because the module may be dirty with finger mark and so on.

9.2 Mounting

- (1) When you mount the module, please be careful not to break the wire or damage the solar cell by twisting the module. According to the load when it mounts, it may be the cause of failure in the future.
- (2) Because the products covered herein are the half-finished products, so please examine the mounting instruction enough in the customer. In no event shall the company be liable for any damages resulting from design and mounting of the method of the customer's installation.
- (3) Transparent resin surface is delicate, so please be careful in handling.
- (4) When you connect a battery to a module, please follow the safe usage direction of the battery manufacturer thoroughly.
- (5) Please connect the backflow prevention circuit so that the current should not flow in when you connect the external source such as storage batteries with this module.
- (6) Please note that the transparent resin used by this module cannot reflow because permeability and reliability might decrease at the high temperature.
- (7) To suppress the influence on the warp, all aspects of the module are recommended to be fixed.
- (8) The plating part that leads to wiring in the module has been exposed to the side of the module's long side. Please do not allow the material with electroconductive to touch in the plating part.

9.3 Using

- (1) Please keep transparent resin surface clean. The electric output characteristics may decrease if the surface is dirty.
- (2) Do not put the module in the liquid.
- (3) Be careful not to make spark near flammable gas.
- (4) Do not expose the module to concentrated sunlight by mirror, lens and so on.
- (5) Under any light other than standard condition (refer to chapter 7.1), for example fluorescent light, the output characteristics described in chapter 7.1 is unavailable.
- (6) The electric output characteristic might decrease because the transparent resin is changed into yellow by ultraviolet rays, etc.
- (7) Do not short-circuit a plus terminal and a minus terminal of the solar cell module. Be careful not to be short-circuited, because it is dangerous to short-circuit the electrode when the solar cell module generates electricity.

10 Others

- (1) Do not expose the content or information of this specification sheet to the third-party without Sharp company agreement.
- (2) The doubt about the content of specification sheet is solved by mutually discussions.
- (3) The dark and light coloring of the solar cell. The color of solar cell surface may differ by manufacturing process condition, but there is no difference in reliability and performance.
- (4) Please do not use the module in series on the outside without permission.
- (5) The pattern on the surface of the solar cells is a silicon grain boundary, and does not have the influence in reliability and performance.

11 Package and packing specification

[Applicability]

This specification applies to a Solar Cell Module delivered as a standard specification.

1. Storage Conditions.

- Normal temperature : 5~40°C
- Normal humidity : 80% (Relative humidity) max.
- Storage period : One year max.
* "Humidity" means "Relative humidity"

2. Baking Condition.

Baking is no necessity.

3. Mounting conditions.

Please mount the ICs as follows in order to prevent the IC quality deteriorating.

3-1. Manual soldering (soldering iron) (one-time soldering only)

- Temperature and period : 300°C max. for 2 seconds / pin max.
- Measuring point : Soldering iron tip.

3-2. Recommended heating condition for repair.

- Refer to the preceding chapter 3-1.

4. Condition for removal of residual flux.

- (1) The entire washing according to wet cannot be applied.
- (2) Top side and bottom side can be cleaned with IPA.

5. Package outline specification.

5-1. Package outline.

- Refer to the attached drawing.

5-2. Terminal surface finish.

- Au PLATING

6. Markings.

6-1. Marking details. (The information on the package should be given as follows.)

- (1) Product name : LR0GC02
- (2) Company name : SHARP
- (3) Date code : (Example) YYWW XXX
YY → Denotes the production year. (Last two digits of the year.)
WW → Denotes the production week. (01 · 02 · ~ · 52 · 53)
XXX → Denotes the production ref code.
- (4) "JAPAN" indicates the country of origin.

6-2. Marking layout.

The layout is shown in the attached drawing.

(However, this layout does not specify the size of the marking character and marking position.)

BOTTOM VIEW

※Mark Area

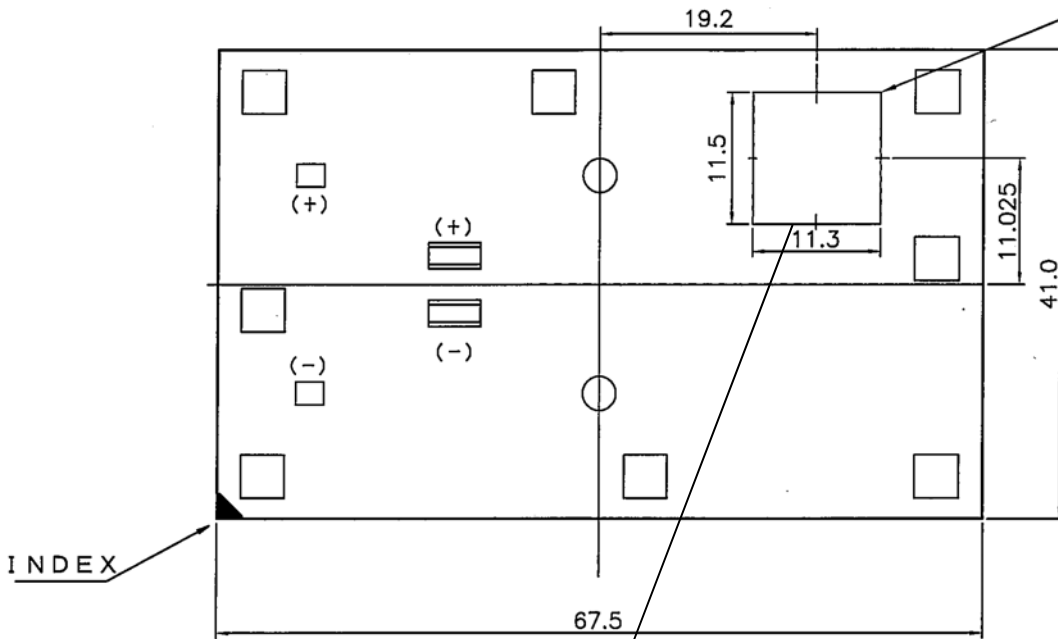

Marking details.

LROGC02
SHARP
JAPAN
YYWWXXX

NAME	SCM006-P-4168		Terminal surface finish	
DRAWING NO.	AA2446	UNIT	mm	Au PLATING
NOTE	NOTE			

PKG SIZE: 67.5x41.0

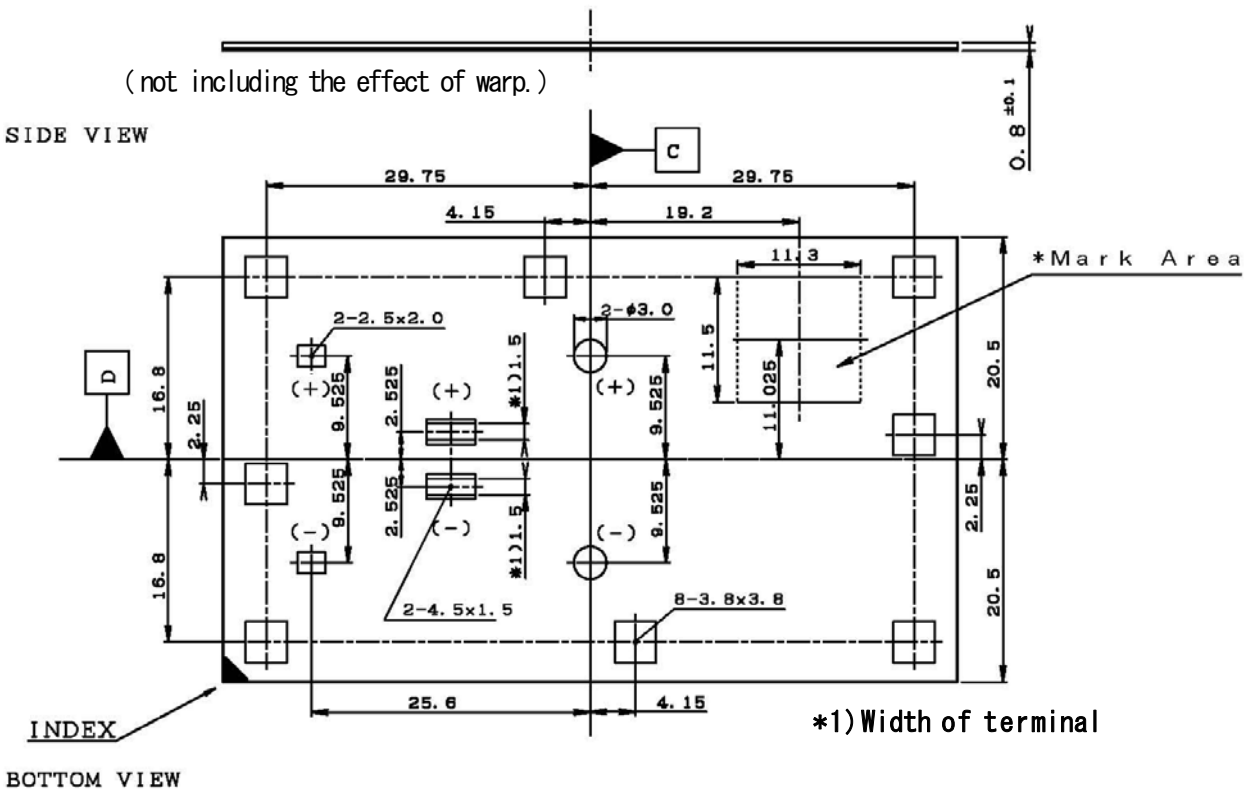
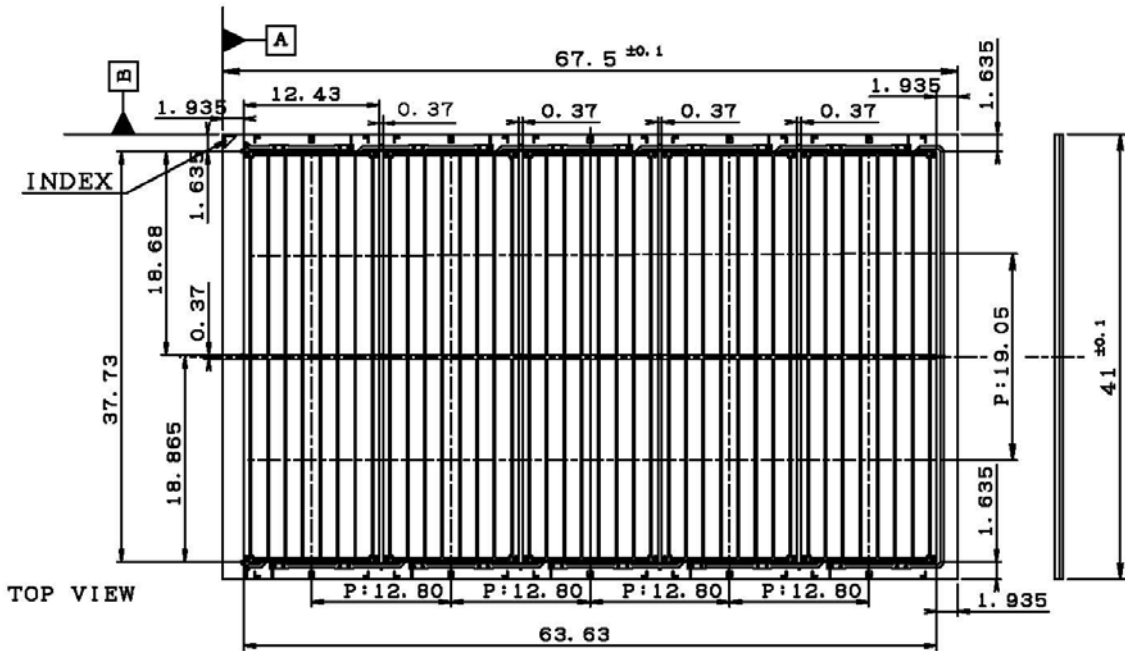

NAME	SCM006-P-4168		Terminal surface finish
DRAWING NO.	AA2446	UNIT	mm
NOTE	Au PLATING		
NOTE	NOTE		

7. Packing Specifications (Dry packing for surface mount packages.)

7-1. Packing materials.

Material name	Material specifications	Purpose
Conductive bag	Polyethylene (200 devices)	Packing the devices. (10 trays + 1 upper cover tray)
Tray	Conductive plastic (20 devices / tray)	Securing the devices.
Upper cover tray	Conductive plastic (1 tray / inner carton)	Securing the devices.
Sheet	Foaming polyethylene	buffer material
Label	Paper	Indicates part number, quantity, and packed date.
Outer carton	Cardboard (800 devices / outer carton max.)	Outer packing.
Band	Polyisoprene	Securing the devices.

(Devices must be placed on the tray in the same direction.)

7-2. Outline dimension of tray.

Refer to the attached drawing.

8. Precautions for use.

- (1) Opening must be done on an anti-ESD treated workbench.
All workers must also have undergone anti-ESD treatment.
- (2) The trays have undergone either conductive or anti-ESD treatment.
If another tray is used, make sure it has also undergone conductive or anti-ESD treatment.
- (3) The devices should be mounted within one year of the date of delivery.

9. Chemical substance information in the product.

Product Information Notification based on Chinese law, Management Methods for Controlling Pollution by Electronic Information Products.

Names and Contents of the Toxic and Hazardous Substances or Elements in the Product

Lead (Pb)	Mercury (Hg)	Cadmium (Cd)	Hexavalent Chromium (Cr (VI))	Polybrominated Biphenyls (PBB)	Polybrominated Diphenyl Ethers (PBDE)
×	○	○	○	○	○

○ : indicates that the content of the toxic and hazardous substance in all the homogeneous materials of the part is below the concentration limit requirement as described in SJ/T 11363-2006.
 × : indicates that the content of the toxic and hazardous substance in at least one homogeneous material of the part exceeds the concentration limit requirement as described in SJ/T 11363-2006 standard.

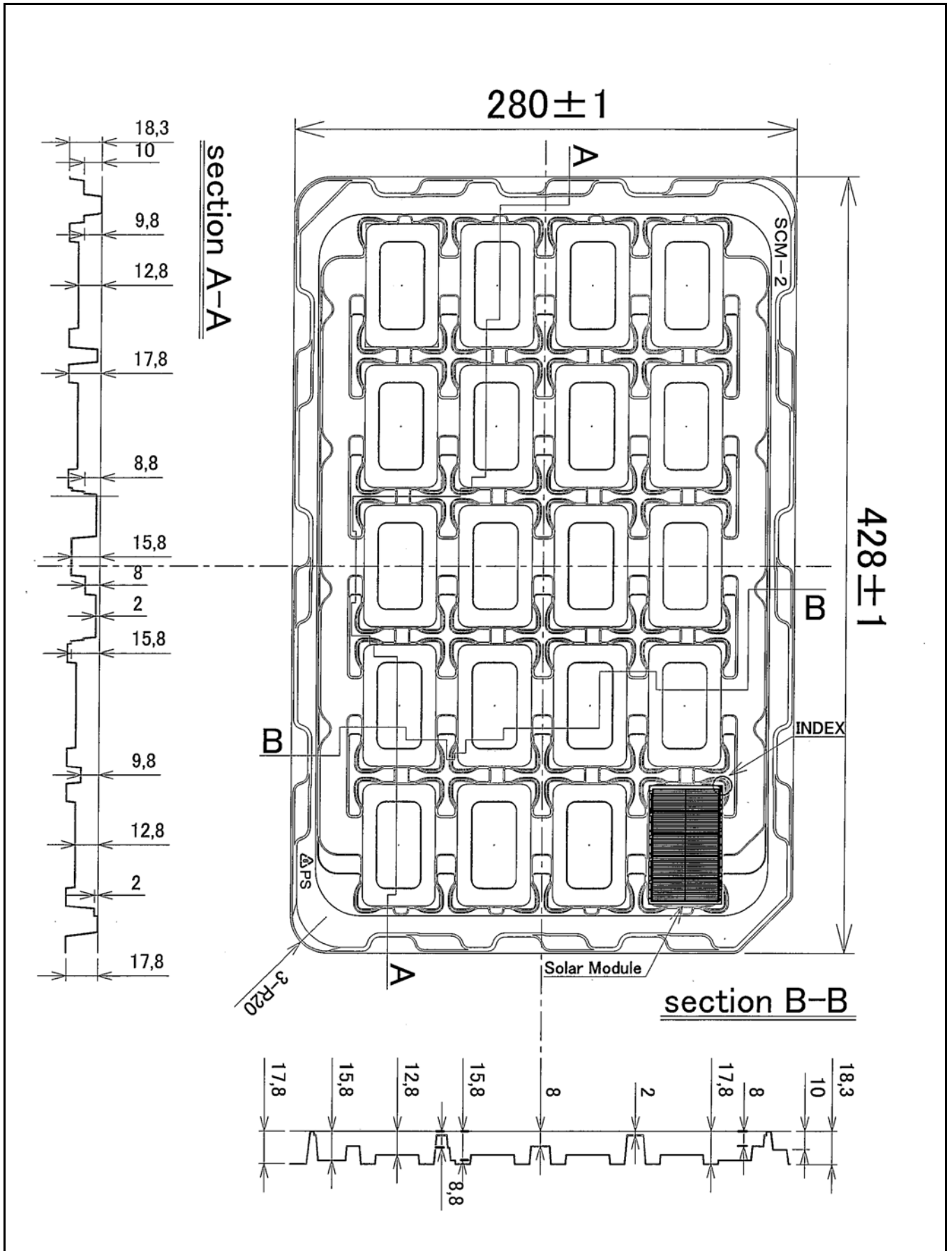

NAME		SCM02		NOTE
DRAWING NO.	CV1082	UNIT	mm	

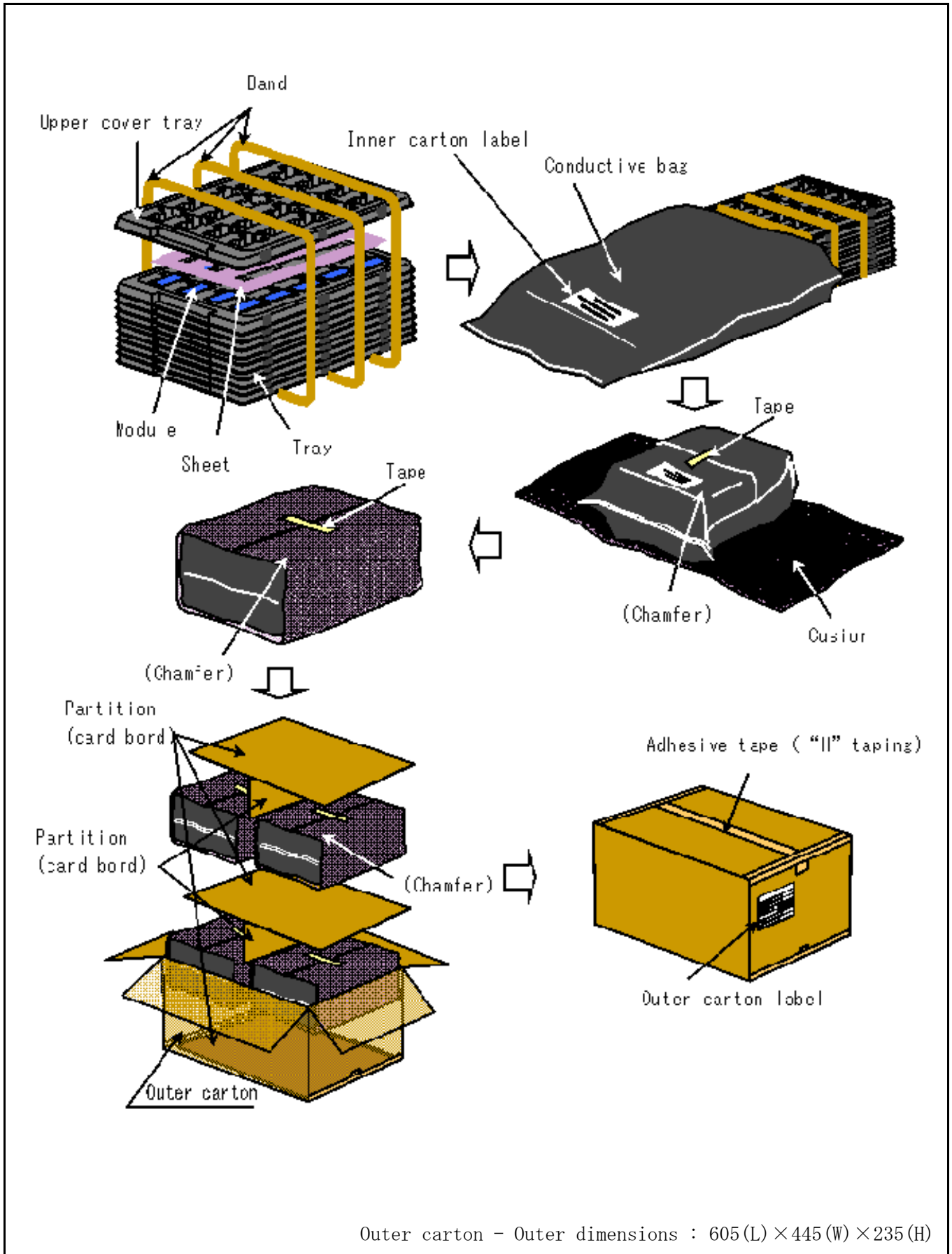

NAME	Packing specifications			NOTE
DRAWING NO.	BJ632	UNIT	mm	

Inner carton label

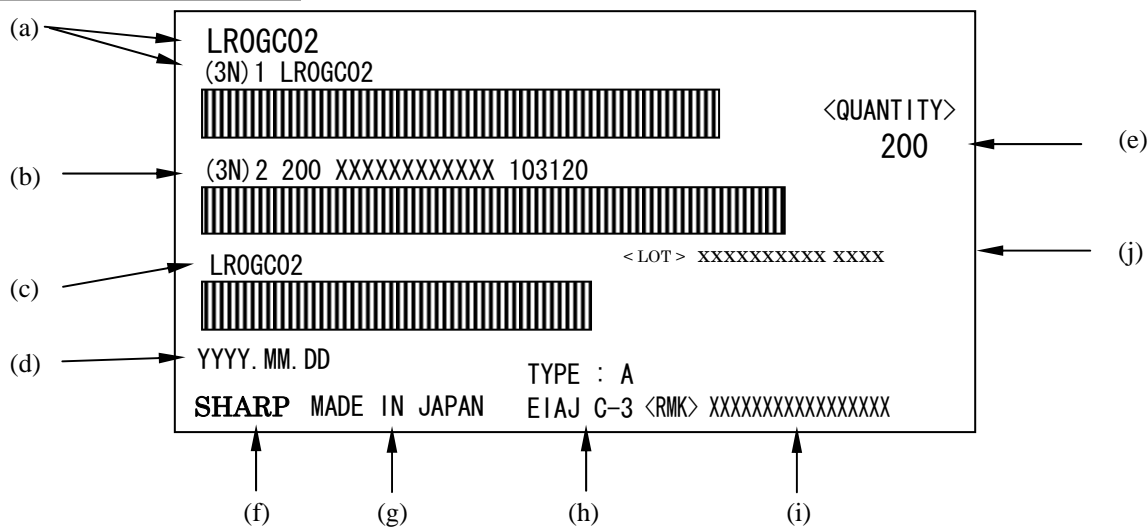

Outer carton label

(Former) EIAJ B Standard conforming

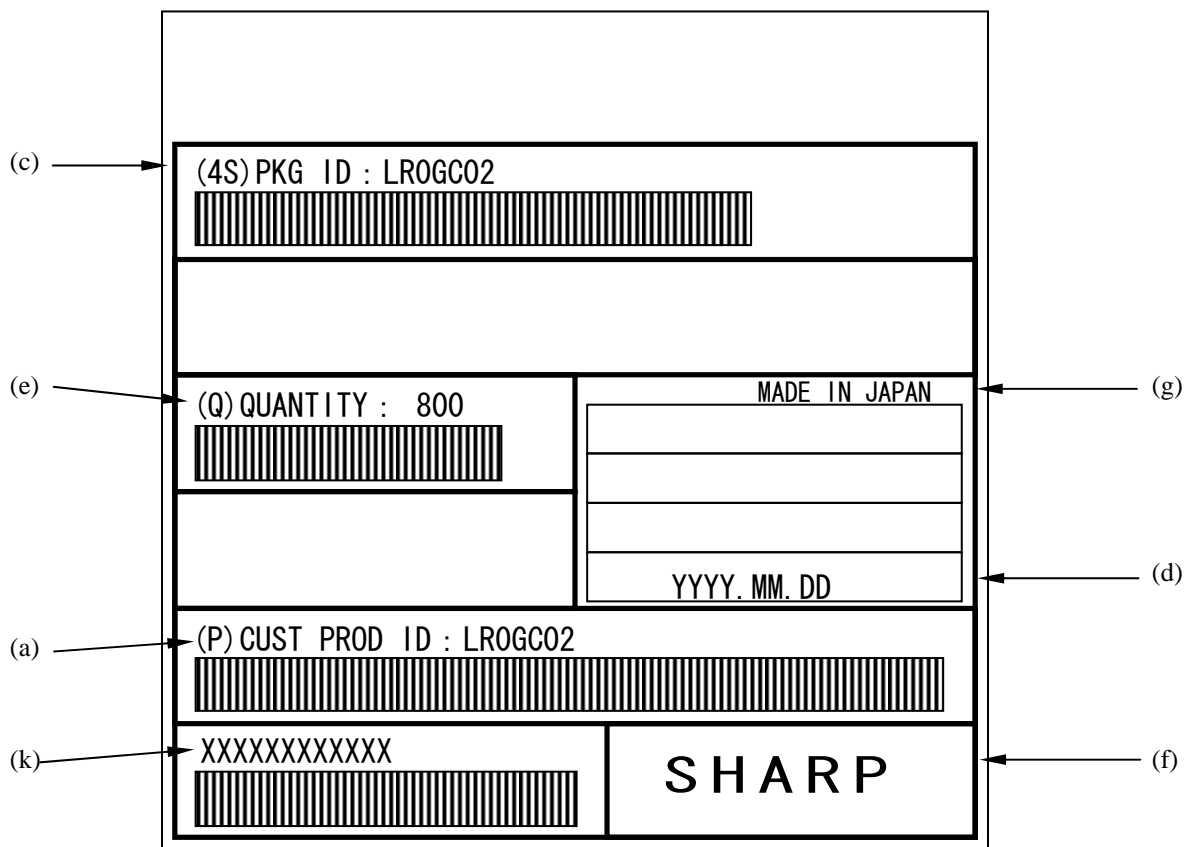

- (a) Product name
- (b) Quantity PD lot Company code
- (c) Part No. (SHARP)
- (d) Packed date
- (e) Quantity
- (f) "SHARP" Logo
- (g) The country of origin
- (h) Type name (Conformity standard)
- (i) Sharp management No.
- (j) Sharp control No.
- (k) Shipment lot